



INSTALLATION INSTRUCTIONS

Accessory
TRUNK SPOILER

Application
2016 ACCORD
2-DOOR

Publications No.
VERSION 1

Issue Date
AUG 2015

PARTS LIST

Trunk spoiler



5 Clips A



6 Clips B

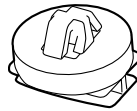

2 Nuts



TOOLS AND SUPPLIES REQUIRED

Phillips screwdriver

10 mm Open end wrench

Ratchet

8 mm Sockets

Torque wrench

Diagonal cutters

The following tool is available through the Honda Tool and Equipment Program. On the iN, click on: Service > Service Bay > Tool and Equipment Program, then enter the number under "Search." Or, call 888-424-6857.

- Trim Tool Set (T/N SOJATP2014)

Illustration of the Trunk Spoiler on the Vehicle

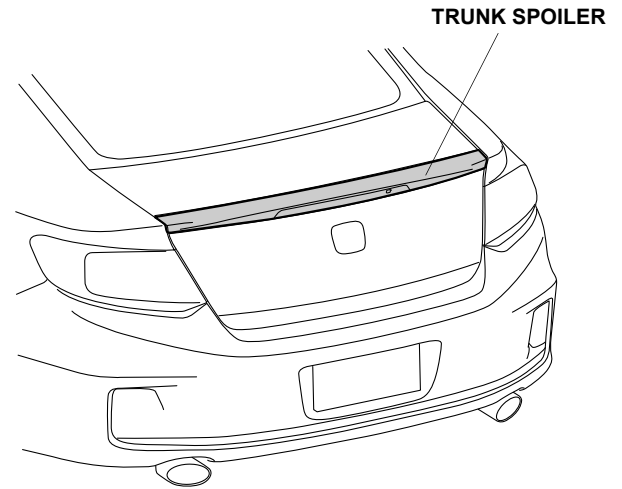

QB40308AY

INSTALLATION

Customer Information: The information in this installation instruction is intended for use only by skilled technicians who have the proper tools, equipment, and training to correctly and safely add equipment to your vehicle. These procedures should not be attempted by "do-it-yourselfers."

NOTE: Be careful not to damage the body.

1. Disconnect the negative cable from the battery.

- Remove the trunk panel (nine clips).

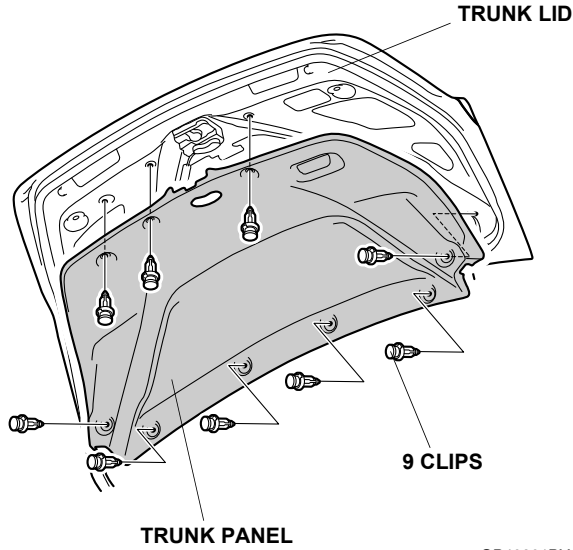

QB40201BY

- Remove the two bolts from the trunk lid.

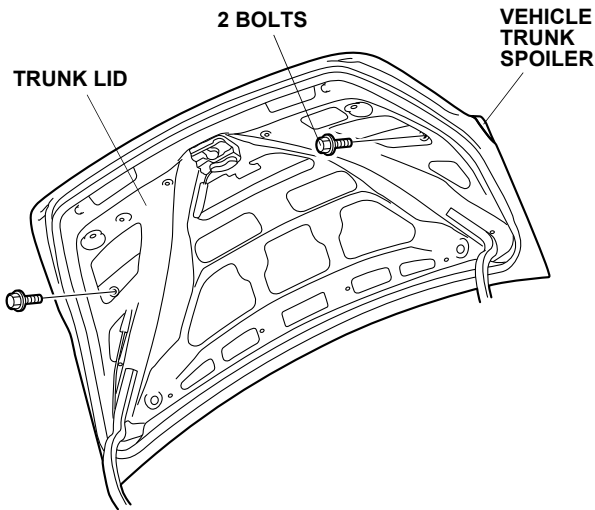

QB40202AY

- Close the trunk lid. Release the vehicle trunk spoiler (eleven clips).

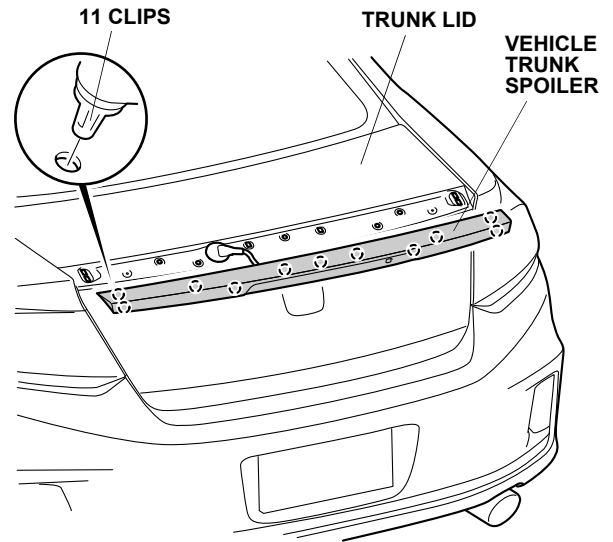

QB40203BY

- Cut the clip. Do not damage the vehicle harness.

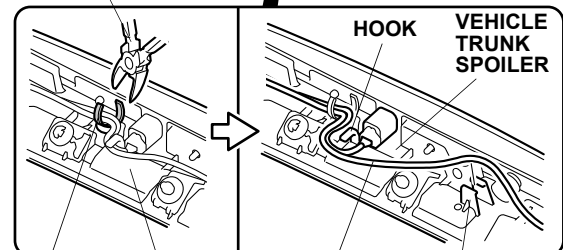
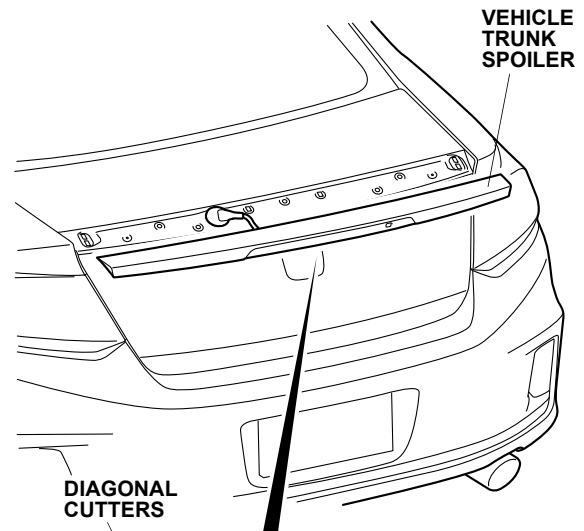

QB80827AB

- Release the vehicle harness from the vehicle trunk spoiler.

- Remove the vehicle trunk spoiler (unplug the vehicle connectors).

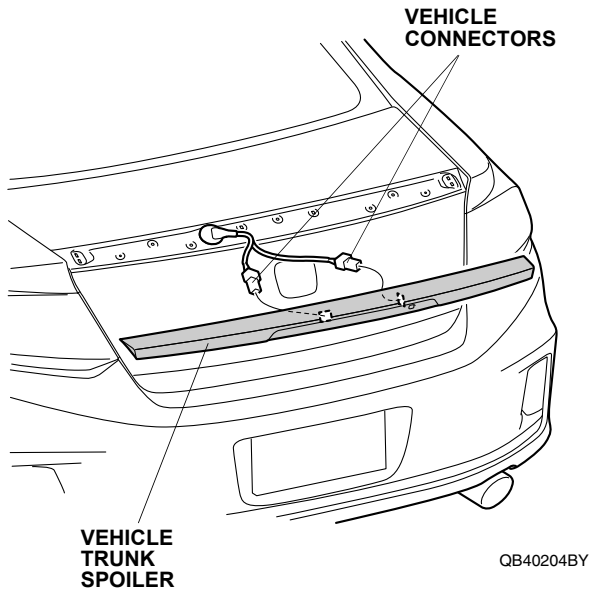

- Remove the high-mount brake light from the vehicle trunk spoiler (three self-tapping screws). Set the vehicle trunk spoiler aside, it will not be reused.

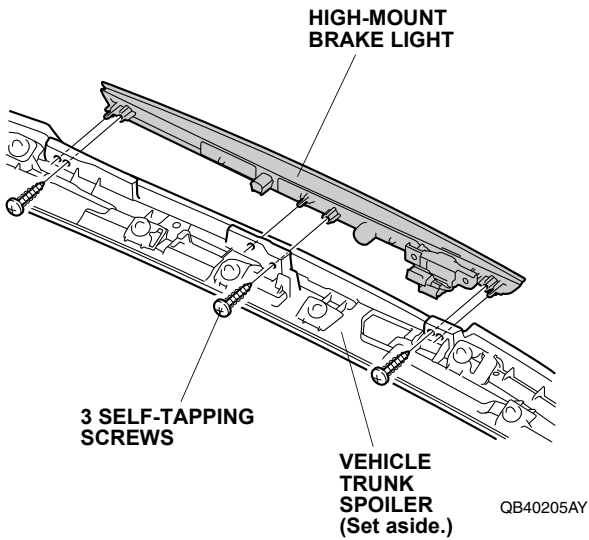

- Install the high-mount brake light to the new trunk spoiler with the three self-tapping screws removed in step 8.

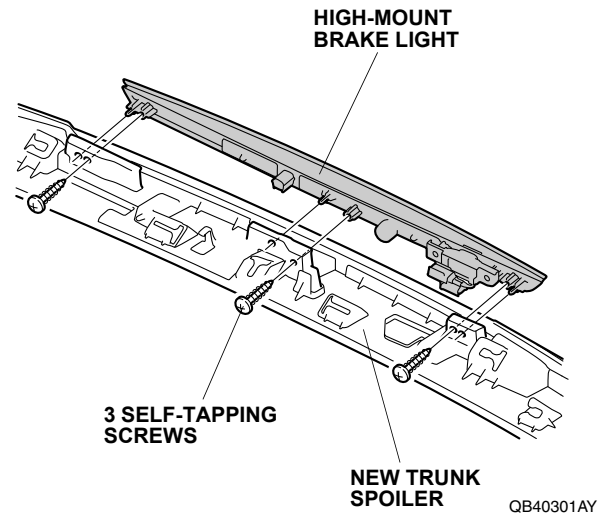

- Install five clips A to the new trunk spoiler.

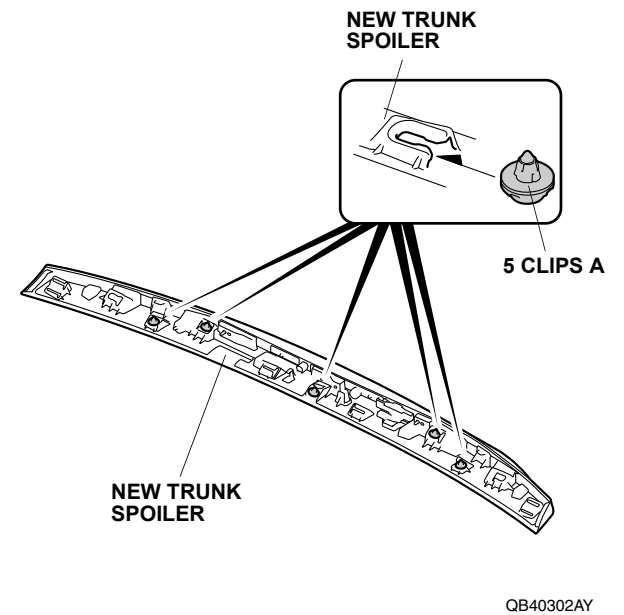

11. Install six clips B to the new trunk spoiler.

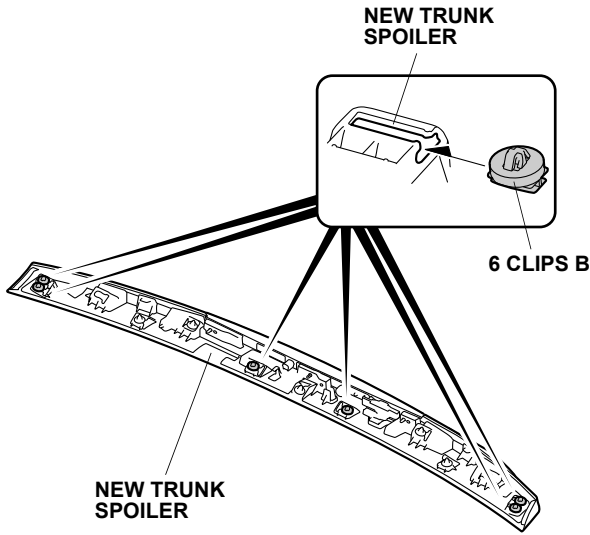

QB40303AY

12. Install two nuts to the new trunk spoiler.

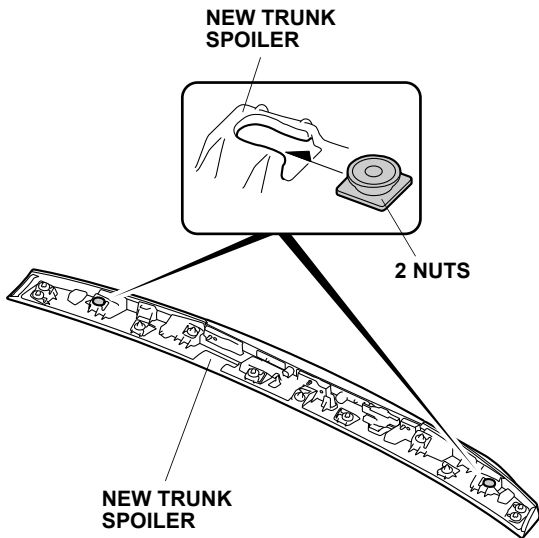

QB40304AY

13. Plug the vehicle connectors into the high-mount brake light.

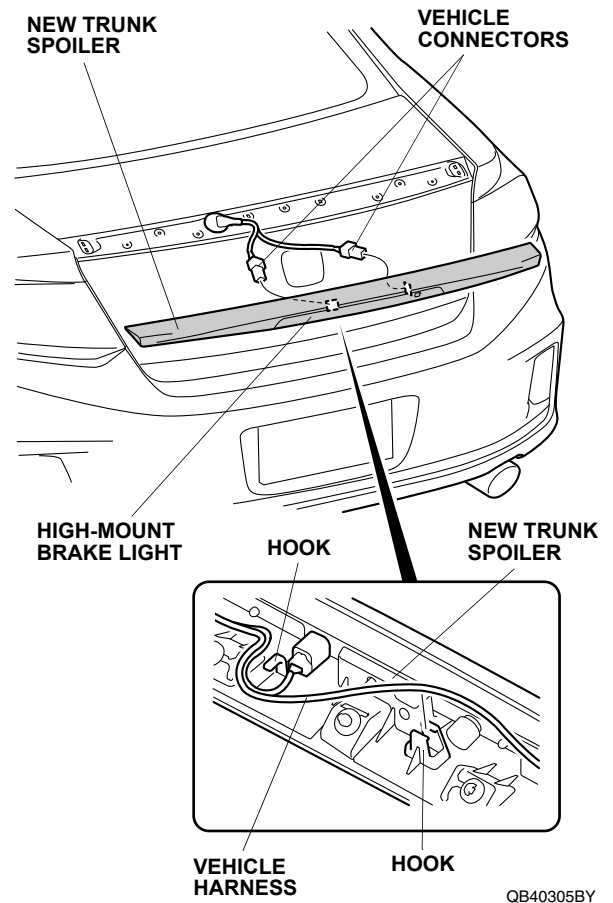

QB40305BY

14. Secure the vehicle harness to the new trunk spoiler.
15. Firmly press the new trunk spoiler against the trunk lid until you hear a click. This ensures proper engagement of the clips to the trunk.

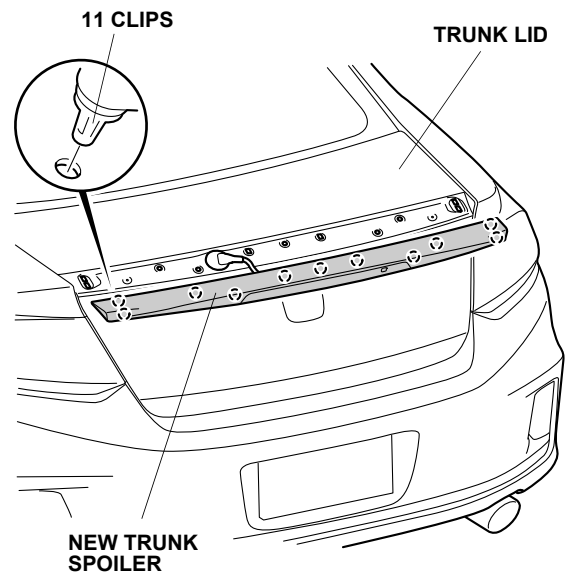

QB40306BY

16. Open the trunk lid. Secure the new trunk spoiler to the trunk lid with the two bolts removed in step 3. Torque the bolts to 5 N·m (3.7 lbf·ft).

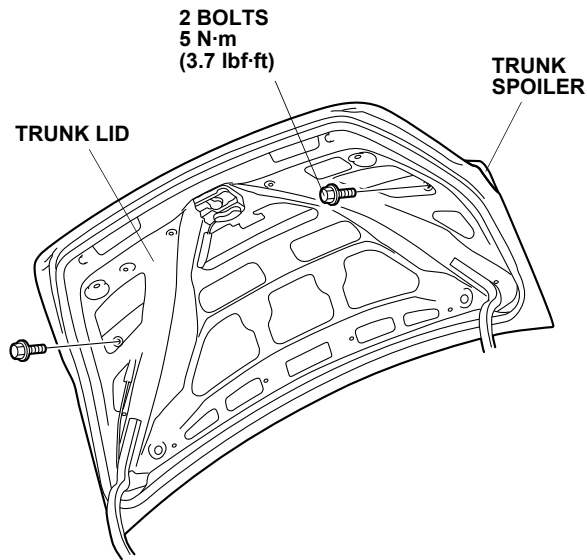

QB40307AY

17. Check that all wire harness are routed properly and all connectors are plugged in.
18. Reinstall the trunk panel.
19. Reconnect the negative cable to the battery.
20. Press and hold the radio power button for two seconds to restore the radio and navi (if equipped) system functions.
21. Reset the clock on vehicle without navigation.