



INSTALLATION INSTRUCTIONS

Accessory

BODY SIDE MOLDING

Application

2010 RIDGELINE

Publications No.

All 42127

Issue Date

AUG 2009

PARTS LIST

Left front upper molding

Left front lower molding

Left rear upper molding

Left rear lower molding

Right front upper molding

Right front lower molding

Right rear upper molding

Right rear lower molding

8 Alcohol pads

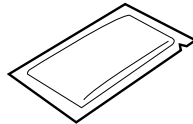
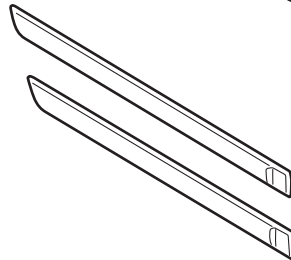
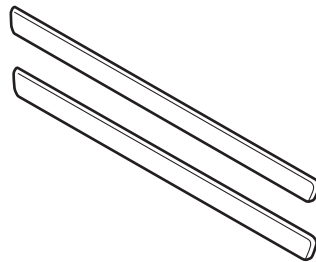
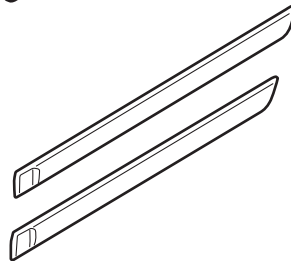
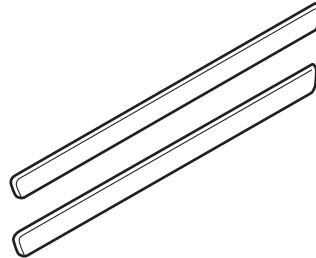

TOOLS REQUIRED

Masking tape

Tape measure

Hard rubber roller

INSTALLATION

NOTE:

- Be careful not to damage the body paint finish.
- This body side molding kit should be installed only if the ambient air temperature is above 60°F (15°C).
- To allow the adhesive to cure, do not wash the vehicle for 24 hours.
- These instructions show the body side molding being installed on the left side of the vehicle; the same procedure applies to installing the body side molding on the right side of the vehicle.

Installing the Front Upper Molding

1. Measure and mark the left front door, and attach masking tape in the area shown.

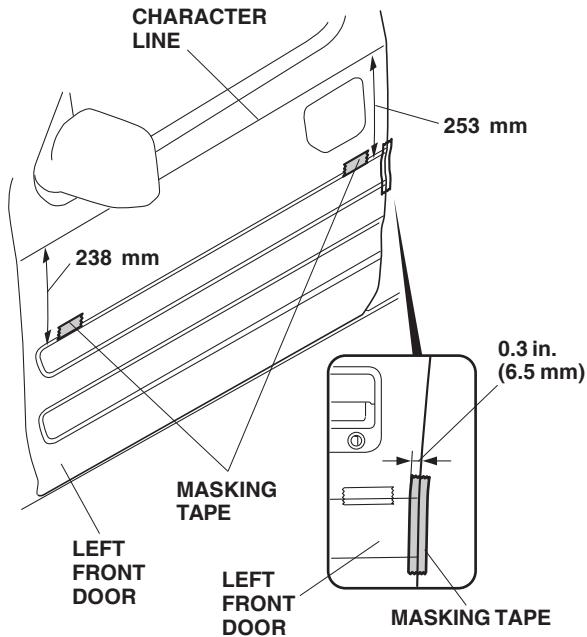

2. On the inside of the left front upper molding, attach a strip of masking tape to the ends of the long adhesive backing and peel back 1-1/2 to 2 in. (3-5 cm) of the adhesive backing. Tape the ends to the front of the moldings. Remove and discard all other adhesive backings.

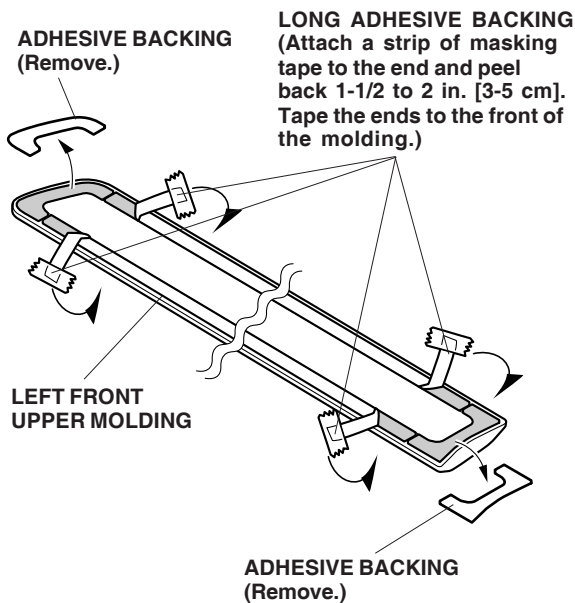

3. Using an alcohol pad, clean the door where the left front upper molding will attach.
4. Align the front and the rear end of the left front upper molding with the masking tapes. Attach the rear edge of the molding to the edge of the door. Continue holding the molding in alignment, and carefully pull out the adhesive backing from under each side; then press the molding into place.

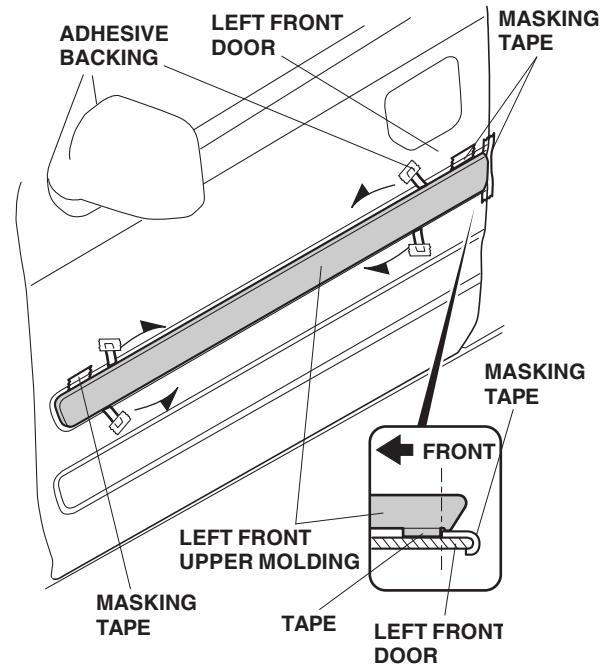

5. Using a hard rubber roller, apply pressure against the molding, and roll from one end to the other.

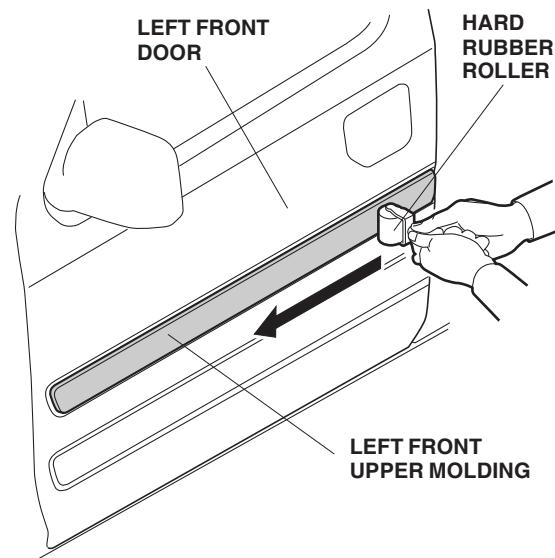

Installing the Front Lower Molding

6. Measure and mark the left front door, and attach masking tape in the area shown.

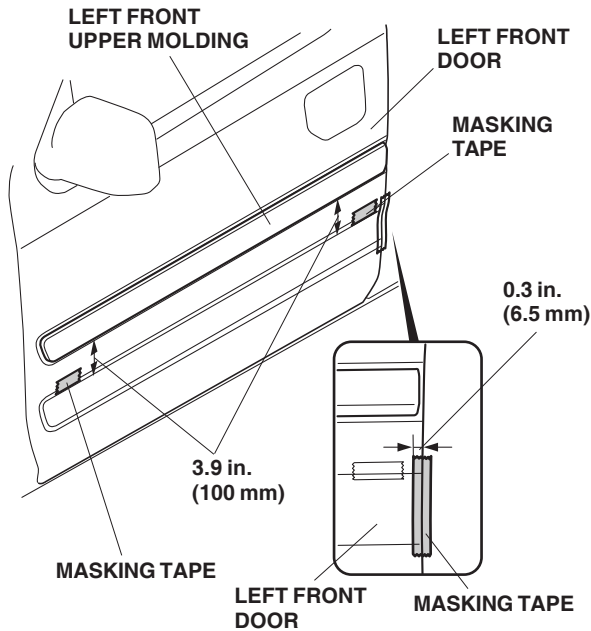

7. On the inside of the left front lower molding, attach a strip of masking tape to the ends of the long adhesive backing and peel back 1-1/2 to 2 in. (3-5 cm) of the adhesive backing. Tape the ends to the front of the moldings. Remove and discard all other adhesive backings.

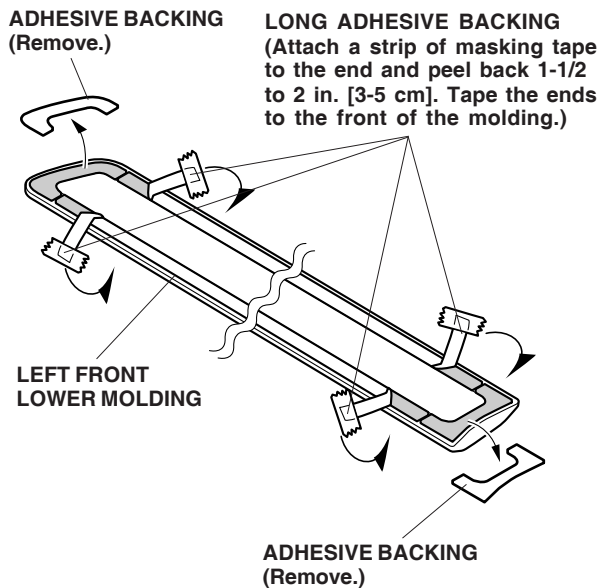

8. Using an alcohol pad, clean the door where the left front lower molding will attach.
9. Align the front and the rear end of the left front lower molding with the masking tapes. Attach the rear edge of the molding to the edge of the door. Continue holding the molding in alignment, and carefully pull out the adhesive backing from under each side; then press the molding into place.

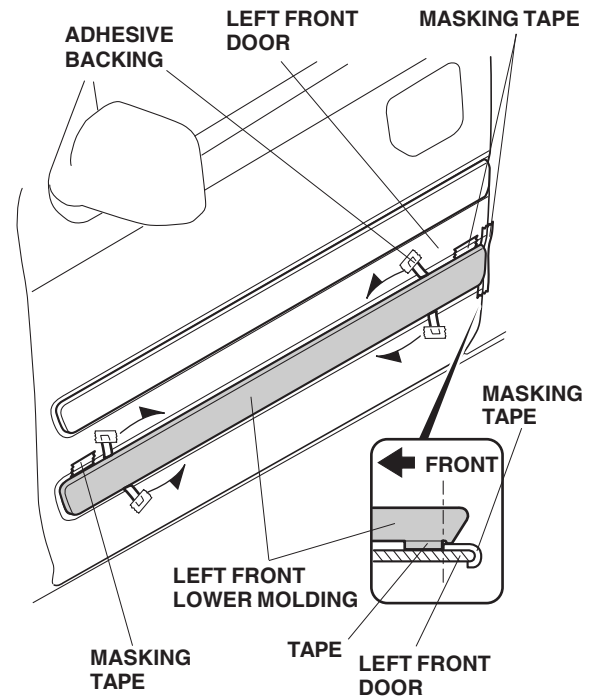

10. Using a hard rubber roller, apply pressure against the molding, and roll from one end to the other.

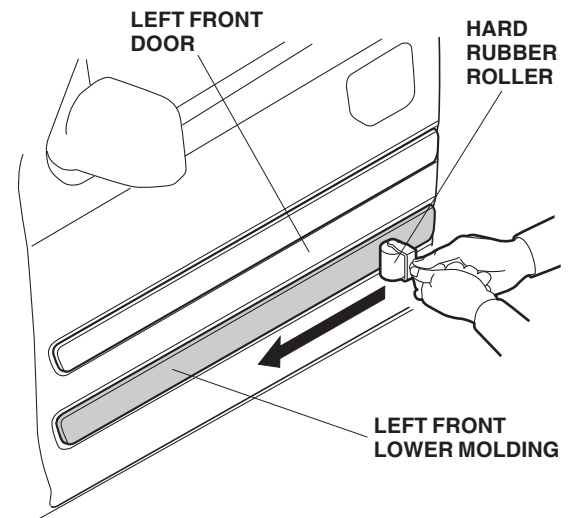

Installing the Rear Upper Molding

11. Measure and mark the left rear door, and attach masking tape in the area shown.

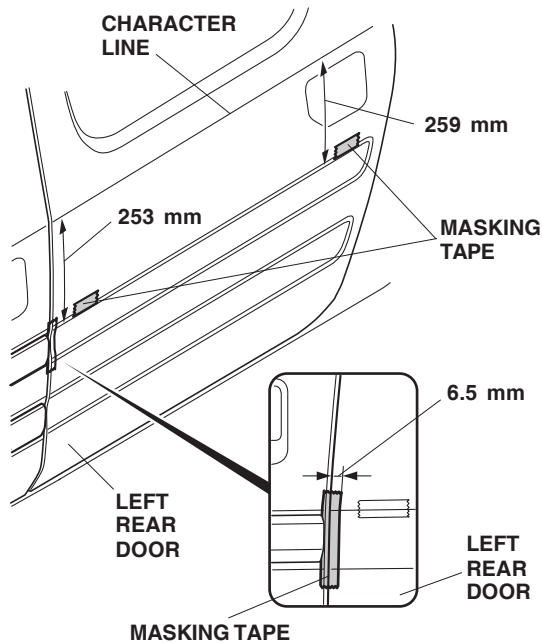

12. On the inside of the left rear upper molding, attach a strip of masking tape to the ends of the long adhesive backing and peel back 1-1/2 to 2 in. (3-5 cm) from the adhesive backing. Tape the ends to the front of the moldings. Remove and discard all other adhesive backings.

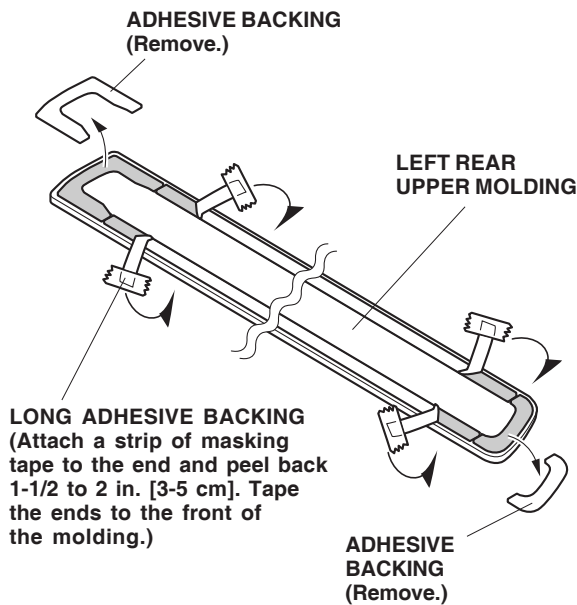

13. Using an alcohol pad, clean the door where the left rear upper molding will attach.
14. Align the front and rear end of the left rear upper molding with the masking tapes. Attach the front edge of the molding to the edge of the door. Continue holding the molding in alignment, and carefully pull out the adhesive backing from under each side; then press the molding into place.

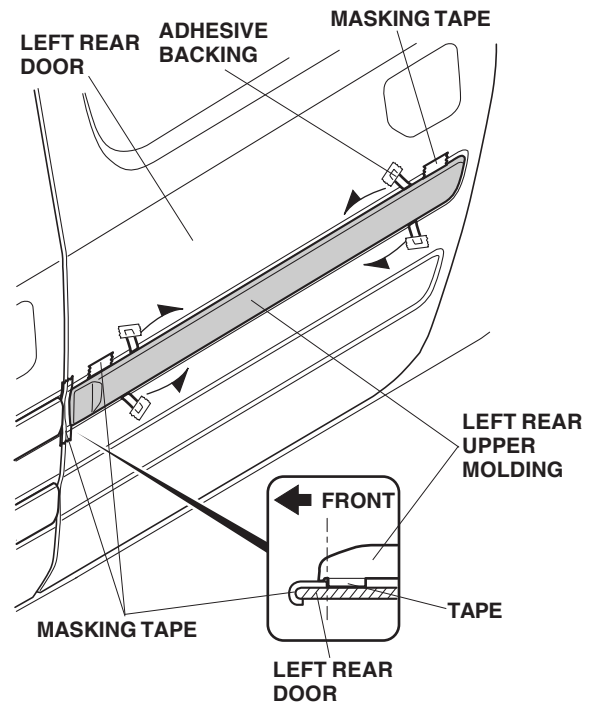

15. Using a hard rubber roller, apply pressure against the molding, and roll from one end to the other.

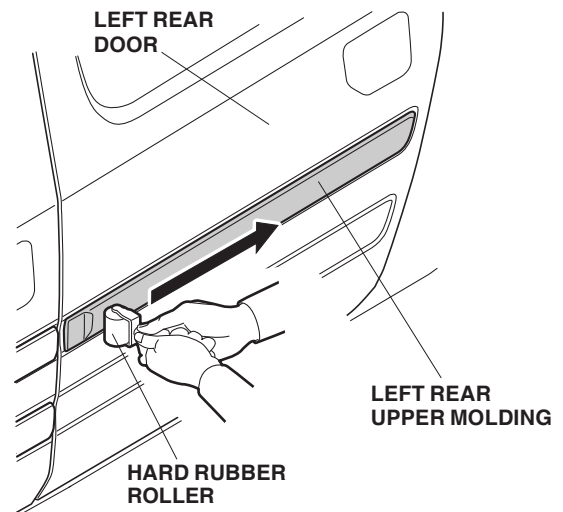

Installing the Rear Lower Molding

16. Measure and mark the left rear door, and attach masking tape in the area shown.

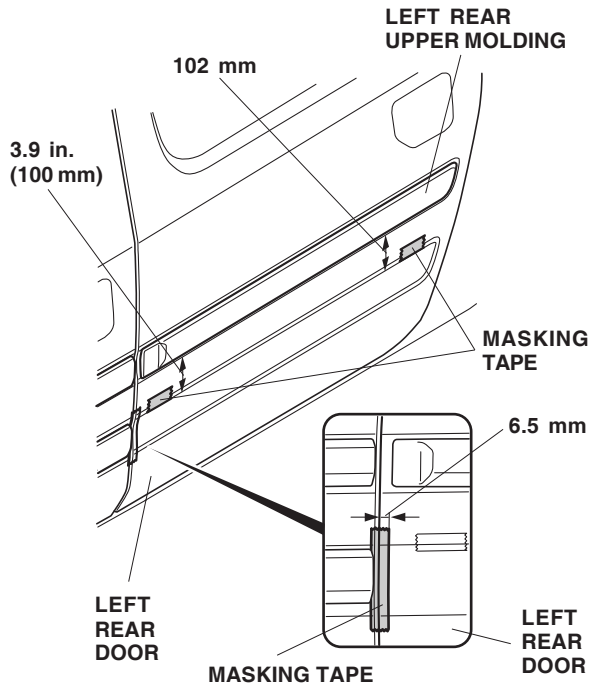

17. On the inside of the left rear lower molding, attach a strip of masking tape to the ends of the long adhesive backing and peel back 1-1/2 to 2 in. (3-5 cm) from the adhesive backing. Tape the ends to the front of the moldings. Remove and discard all other adhesive backings.

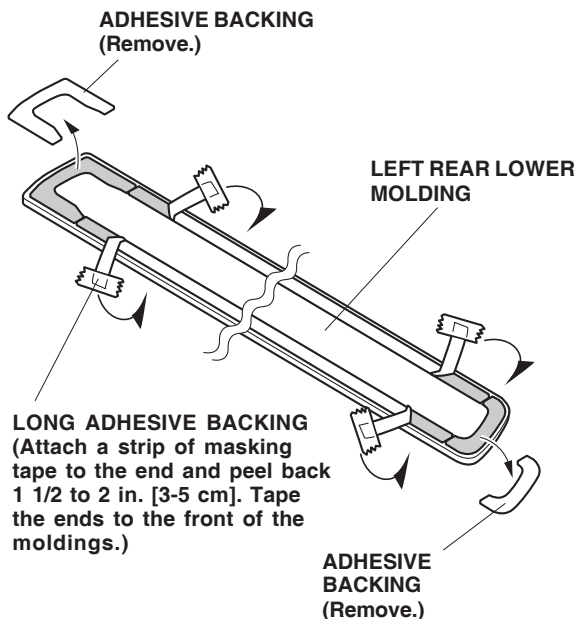

18. Using an alcohol pad, clean the door where the left rear lower molding will attach.
19. Align the front and rear end of the left rear lower molding with the masking tapes. Attach the front edge of the molding to the edge of the door. Continue holding the molding in alignment, and carefully pull out the adhesive backing from under each side; then press the molding into place.

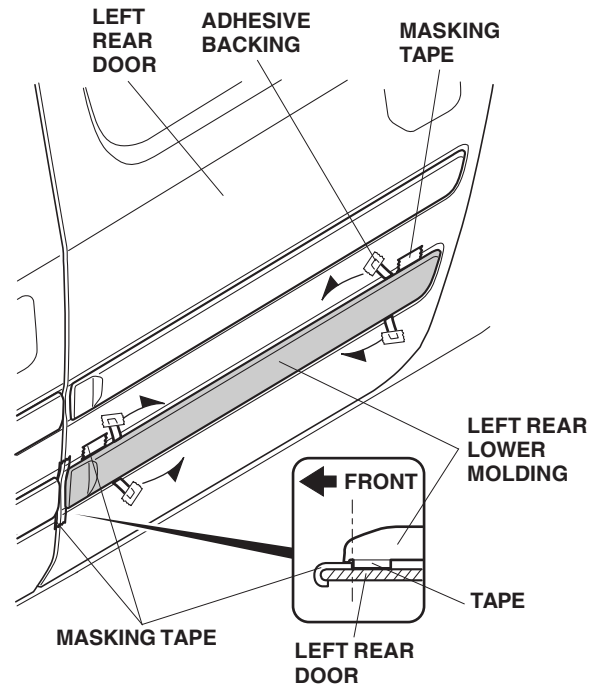

20. Using a hard rubber roller, apply pressure against the molding, and roll from one end to the other.

