



INSTALLATION INSTRUCTIONS

Accessory
AUTOMATIC DAY/NIGHT MIRROR

Application
2010 ACCORD CROSSTOUR

Publications No.
All 41936
Issue Date
NOV 2009

PARTS LIST

**Automatic Day/Night Mirror Attachment Kit
P/N 08V03-TP6-100D**

Harness

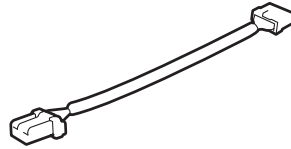

Harness cover

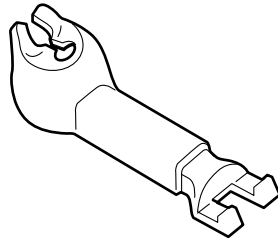

EPT sealer

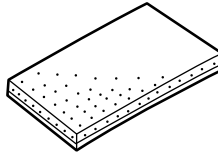

**Automatic Day/Night Mirror Kit
P/N 08V03-TP6-100A**

Automatic day/night mirror

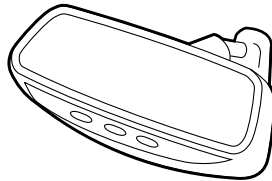

Spring



Operating Instructions

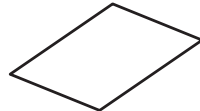

TOOLS AND SUPPLIES REQUIRED

Flat-tip screwdriver

Phillips screwdriver

Isopropyl alcohol

Shop towel

Clip remover

Flashlight

Needle nose pliers

Scissors

Plastic Trim Tool (T/N SILTRIMTL10)

Illustration of the Automatic Day/Night Mirror Installed on the Vehicle

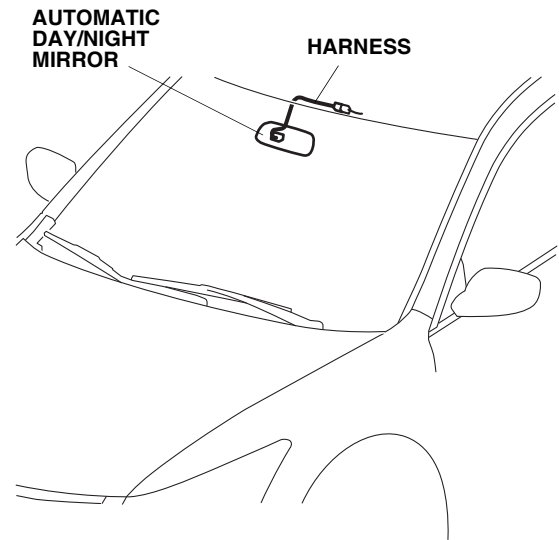

INSTALLATION

Customer Information: The information in this installation instruction is intended for use only by skilled technicians who have the proper tools, equipment, and training to correctly and safely add equipment to your vehicle. These procedures should not be attempted by “do-it-yourselfers.”

1. Make sure you have the anti-theft codes for the audio and navigation system (if equipped), then write down the radio station presets.
2. Disconnect the negative cable from the battery.
3. Using a plastic trim tool, disengage the eight retaining tabs and remove the left and right lenses from the roof console.

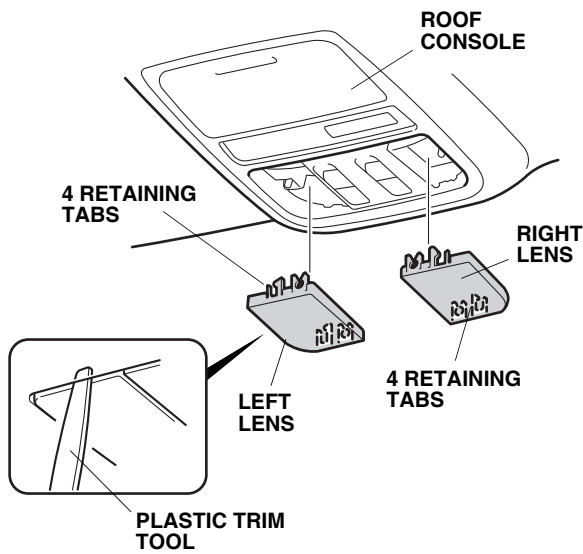

4. Open the sunglass holder. Remove the four screws (two black and two silver) and let the roof console drop down. Unplug the vehicle connectors and remove the roof console.

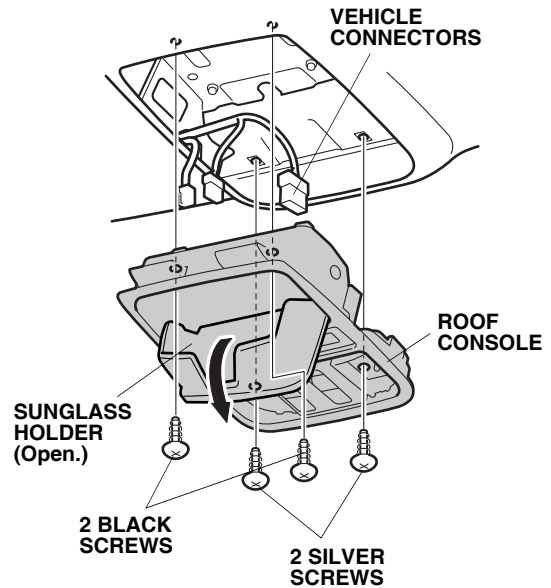

5. Remove the two sunvisor holders by turning them 45°.

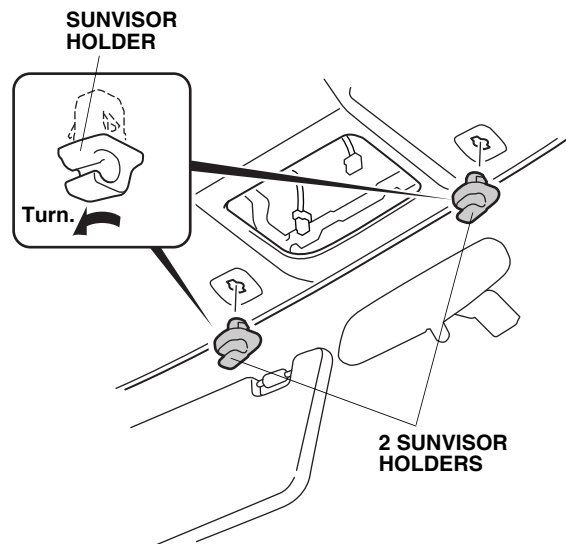

- Turn the left sunvisor toward the driver's seat.

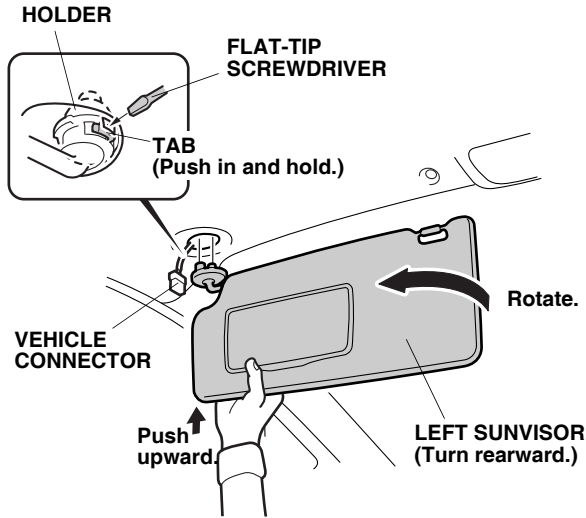

- Locate the slot in the sunvisor holder, and insert a flat-tip screwdriver into the slot. Push in and hold the tab.
- While holding the tab, push up on the left sunvisor and rotate it towards the door. Unplug the vehicle connector and remove the left sunvisor.
NOTE: If the tab did not stay pushed in, return the left sunvisor to its original position and repeat steps 6 through 8.

- Remove the rearview mirror from the mirror holder by rotating the stay 90° clockwise.

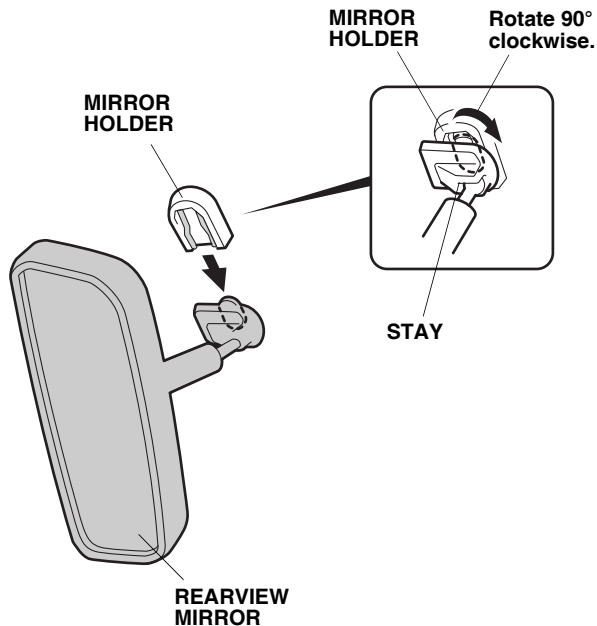

- Replace the spring. Slide the automatic day/night mirror stay onto the mirror holder, then turn the mirror stay counterclockwise as shown.

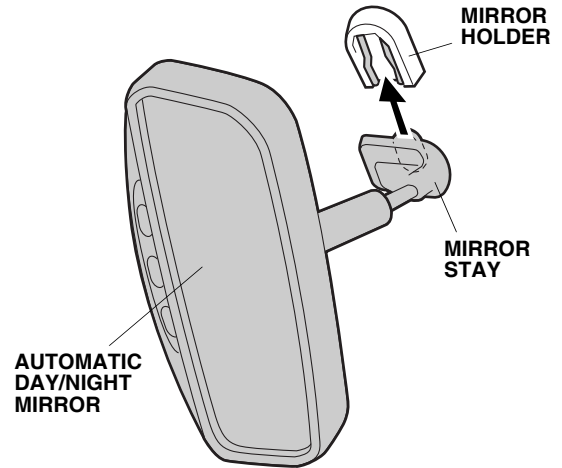
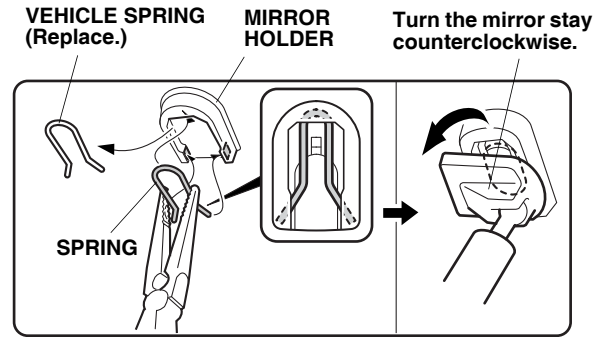

- Plug the 4-pin connector end of the harness into the vehicle harness 4-pin connector.

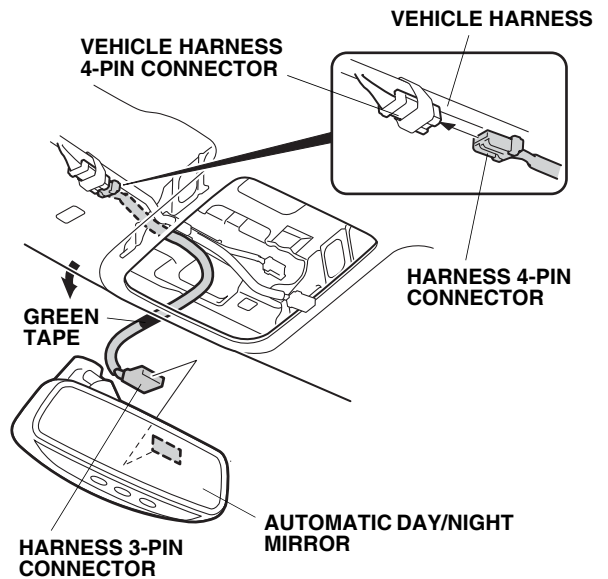

- Plug the harness 3-pin connector into the rear of the automatic day/night mirror.

- Align the green tape on the harness with the edge of the headliner. Route the harness through the grooves in the harness cover. Attach the harness cover to the mirror stay.

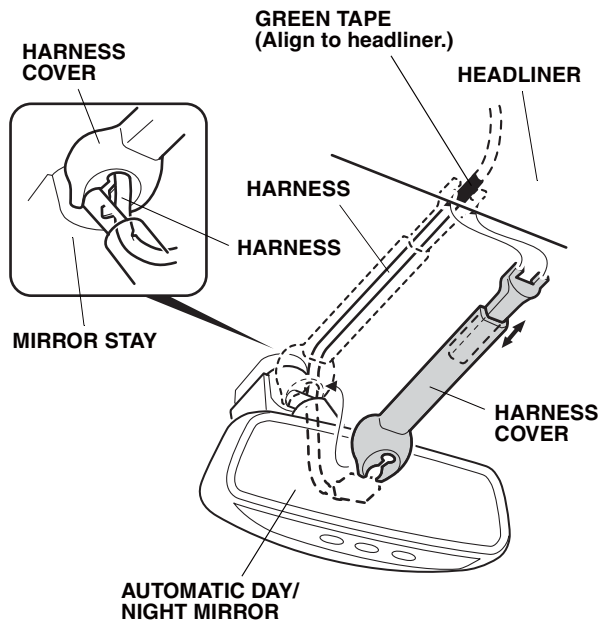

- Slide the harness cover up under the headliner.
- Using scissors, cut one EPT sealer in half.

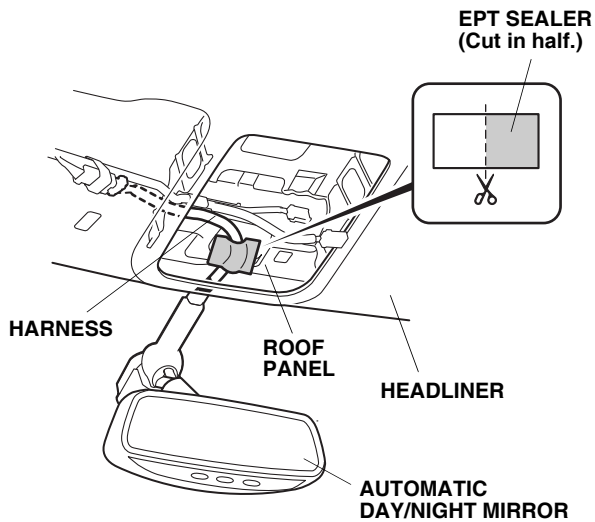

- Using isopropyl alcohol on a shop towel, clean the area where the EPT sealer will attach. Secure the harness to the roof panel with a half piece of EPT sealer.

- Plug in the left sunvisor connector. Insert the holder into the roof panel hole. Push up on the left sunvisor and rotate it clockwise to lock it into place. The connector should be tucked out of the holder.

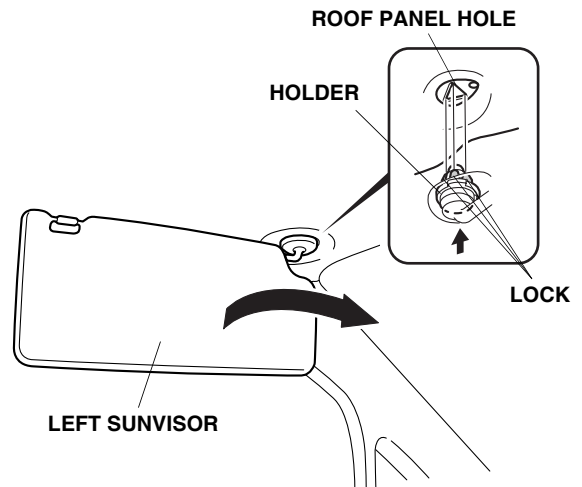

- Check that all wire harnesses are routed properly and all connectors are plugged in.
 - Reinstall all removed parts.
 - Reconnect the negative cable to the battery.
 - Enter the anti-theft codes for the radio and navigation systems, then enter the customer's radio presets.
 - Reset the clock.
- NOTE:** Calibrate the compass according to the supplied operating instructions.
- Put the operating instructions in the glove box.

FUNCTION CHECK

1. Turn the ignition switch to the ON (II) position, but do not start the engine.

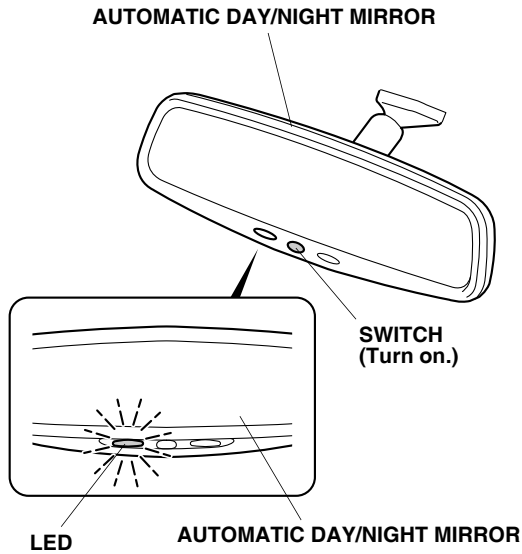

2. Turn the automatic day/night mirror switch on. Check that the LED comes on.
3. Cover the front sensor (FR) on the automatic day/night mirror with your hand, then use a flashlight to light the rear sensor (RR) on the automatic day/night mirror. The mirror surface will dim.

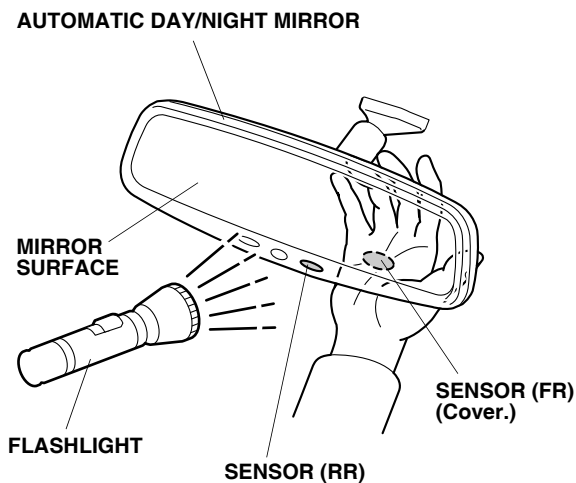

4. With the parking brake applied, press on the brake pedal, and move the select lever to the "R" position. Repeat step 3, and check that the mirror surface does not dim when in the "R" position. If the automatic day/night mirror does not function properly, check the fuse and all connectors.